

ADDITIONAL



Service Manual

STEREO AMPLIFIER

SA-7800 HG

NOTE:

- For detailed instructions on adjustments, circuit descriptions, exploded view, etc., please refer to KU type service manual (ART-344).

1. SPECIFICATIONS

The specifications for HG type is the same as the KU type except for following sections;

Amplifier Section

Continuous Power Output at 1kHz (both channel driven)
 T.H.D. 0.005%, 8 ohms 65 watts per channel
 Input (Sensitivity/Impedance)
 TAPE PLAY 2 (DIN connector) 150mV/50 kilohms
 Output
 TAPE REC 2 (DIN connector) 30mV/80 kilohms
 Hum and Noise (DIN, Continuous Power/50mW)
 PHONO 72dB/64dB
 TUNER, AUX, TAPE PLAY 1, 2 87dB/64dB

Hum and Noise (IHF A-202, '78)
 PHONO 75dB
 TUNER, AUX, TAPE PLAY 1, 2 83dB

Miscellaneous

Power Requirements 220/240V, 50/60Hz
 Power Consumption 650W (max.)
 Dimensions 420(W)x150(H)x376(D)mm
 16-9/16(W)x5-7/8(H)x14-13/16(D)in
 Weight Without Package 12.4kg (27lb 6oz)

2. CONTRAST OF MISCELLANEOUS PARTS

- The *A* mark found on some component parts indicates the importance of the safety factor of the part. Therefore, when replacing, be sure to use parts of identical designation.

P.C. BOARD ASSEMBLIES

Symbol	Description	Part No.		Remarks
		KU type	HG type	
	Power amplifier assembly	GWH-118	GWH-122	
	Power supply assembly	GWR-112	GWR-114	
	Volume assembly	GWX-258	GWX-268	
	Switch assembly 1	GWS-169	GWS-174	
	Terminal assembly	GWX-259	GWX-269	

P.C. BOARD ASSEMBLIES

Symbol	Description	Part No.		Remarks
		KU type	HG type	
	Phone jack assembly Equalizer assembly Tone amplifier assembly Switch assembly 2 Indicator assembly Connector assembly	GWX-260 GWF-115 GWG-123 GWS-170 AWV-001	GWX-270 GWF-115 GWG-123 GWS-170 AWV-003 AWX-062	

OTHERS

Symbol	Description	Part No.		Remarks
		KU type	HG type	
⚠ S11	Lever switch (POWER)	ASK-124	ASK-127	
⚠ S12	Voltage selector	AKX-057	
⚠ C6	Ceramic capacitor 0.01/250V Mylar capacitor 0.01/400V	ACG-001 CQMA 103K 400	
⚠ FU1	Fuse 6A Fuse T3.15A	AEK-109 AEK-042	
⚠ FU2	Fuse 0.8A Fuse T800mA	AEK-111 AEK-031	
⚠ FU3	Fuse 0.8A Fuse T800mA	AEK-111 AEK-031	
⚠ T1	Power transformer	ATT-567	ATT-570	
⚠	AC socket (AC OUTLETS)	AKP-004	
⚠	Recessed plug (AC INLET)	AKP-008	
	AC power cord	ADG-023	
	Strain relief	AEC-327	
	Wooden case	AMM-078	
	Metal case	ANE-223	
	Screw 4x25	ABA-206	
	Screw 4x8	ABA-079	
	Screw 3x10	ABA-181	
	Screw 3x8	ABA-057	for wooden case for metal case for voltage selector for recessed plug

PACKING AND FURNISHED PARTS

Symbol	Description	Part No.		Remarks
		KU type	HG type	
	Packing case	AHD-623	AHD-627	
	Top pad L	AHA-219	
	Top pad R	AHA-220	
	Bottom pad L	AHA-221	
	Bottom pad R	AHA-222	
	Side pad	AHA-130	
	Operating instructions (ENGLISH)	ARB-301	ARB-302	
	Operating instructions (GERMAN/FRENCH)	ARD-131	

3. SCHEMATIC DIAGRAM, P.C. BOARD PATTERN AND PARTS

Schematic Diagram

A

B

C

D

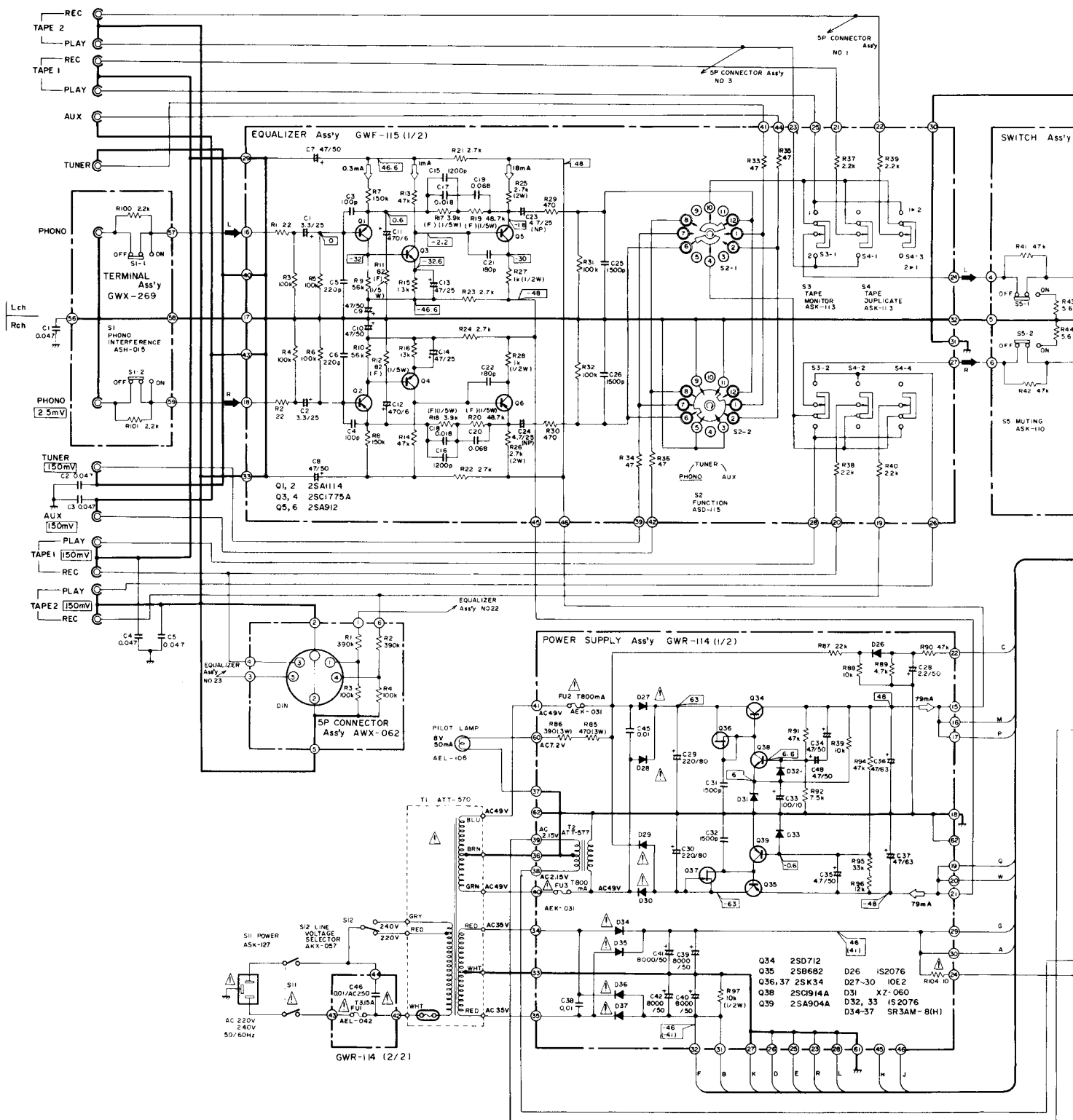

1

2

3

PARTS LIST

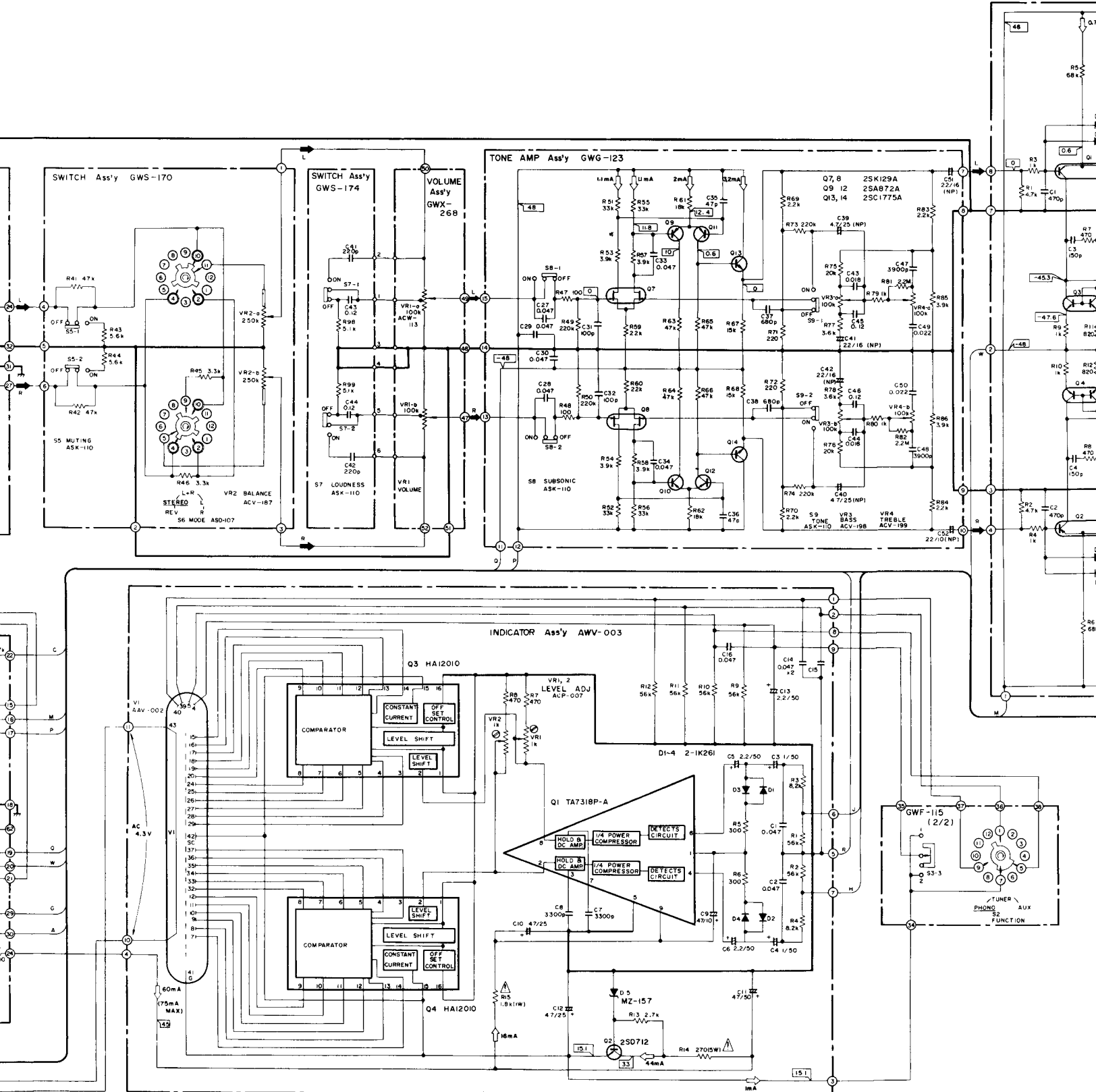

NOTE:

The indicated semiconductors are representative ones only. Other alternative semiconductors may be used and are listed in the parts list.

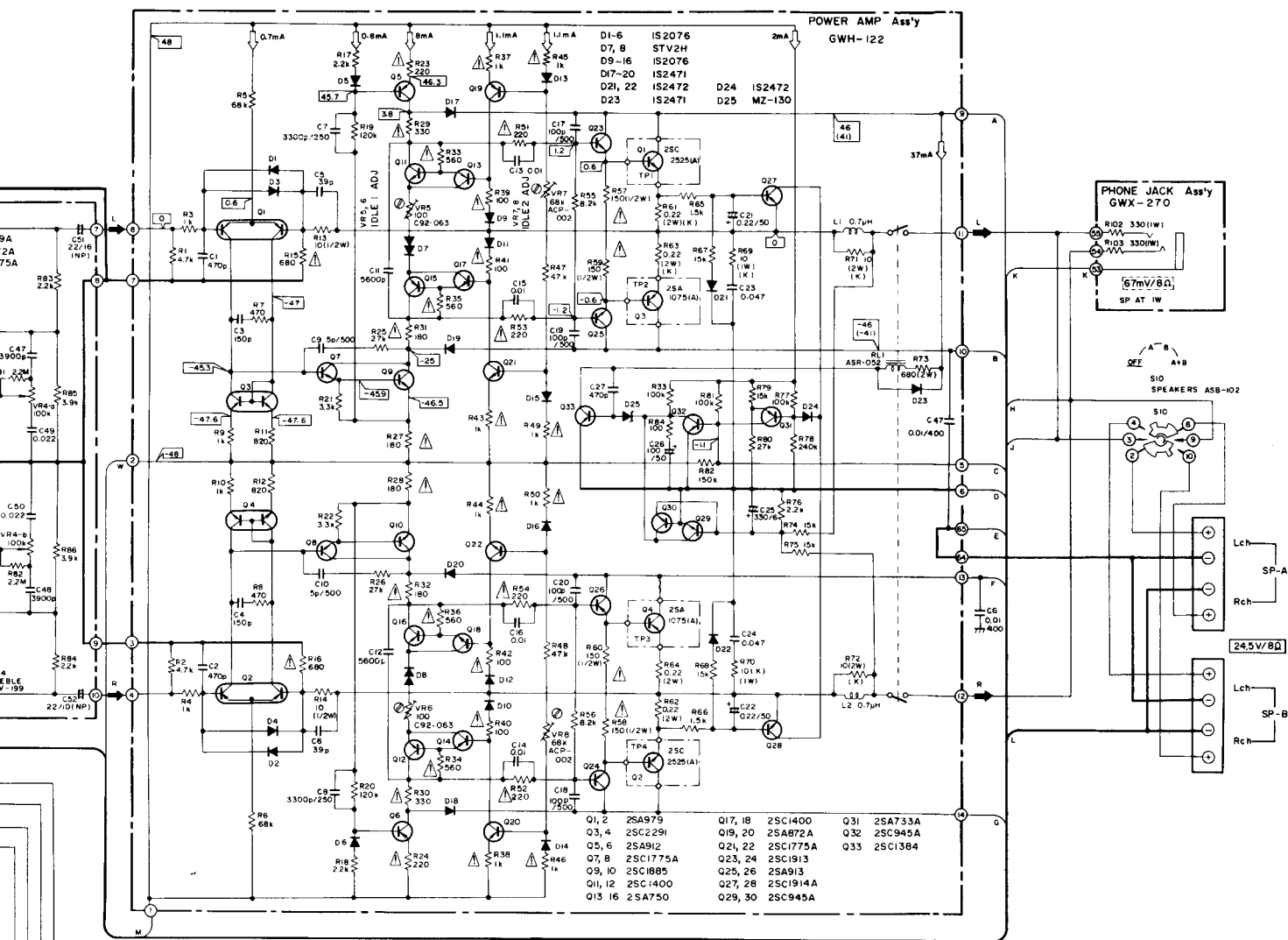

1. RESISTOR.
Indicated in Ω , 1/4W, $\pm 5\%$ tolerance unless otherwise noted; k, Ω , M, M Ω , (F), 1%, $\pm 1\%$, (K), $\pm 10\%$ tolerance.

2. CAPACITORS.
Indicated in capacity (μ F)/voltage (V) unless otherwise noted; p, μ F.
Indication without voltage is 50V except electrolytic capacitor.

3. VOLTAGE, CURRENT.
Signal voltage at 65W + 65W 8 Ω output.
DC voltage (V) at no input signal.
Value in () is DC voltage at rated power.
mA DC current at no input signal.

4. OTHERS:
Signal route.
Adjusting point.
The Δ mark found on some component parts indicates the importance of the safety factor of the part. Therefore, when replacing, be sure to use parts of identical designation.

- SWITCHES.
S1 PHONO INTERFERENCE OFF ON
S2 FUNCTION PHONO TUNER AUX
S3 TAPE MONITOR 1 OFF 2
S4 TAPE DUPLICATE 1 * 2 OFF 2 * 1
S5 MUTING OFF ON
S6 MODE REV STEREO L-R L R
S7 LOUDNESS OFF ON
S8 SUBSONIC FILTER OFF ON
S9 TONE OFF ON
S10 SPEAKERS OFF A+B A+B
S11 POWER OFF ON

The underlined indicates the switch position.

This is the basic schematic diagram, but the actual circuit may vary due to improvements in design.

Power Amplifier Assembly (GWH-122)

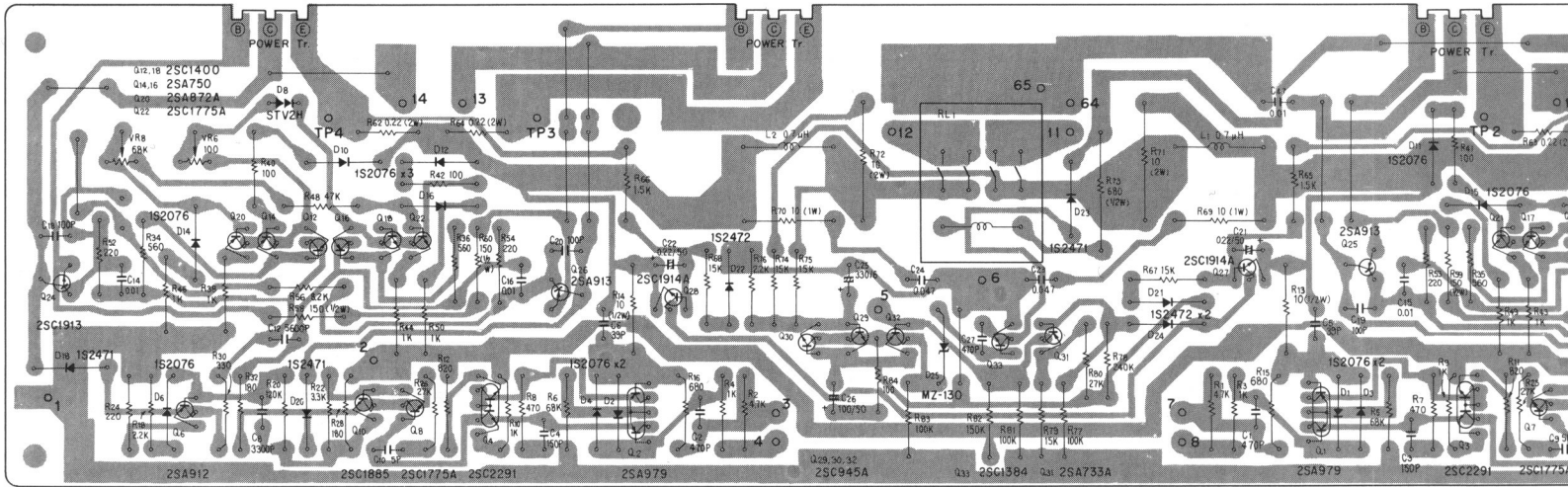

Parts List

CAPACITORS

Part No.	Symbol & Description
CKDYB 471K 50	C1, C2
CCDSL 151K 50	C3, C4
CCDSL 390K 50	C5, C6
CQMA 332K 250	C7, C8
CCDSL 050D 500	C9, C10
CKDYB 562K 50	C11, C12
CQMA 103K 50	C13-C16
CCDSL 101K 500	C17-C20
CEANL R22M 50	C21, C22
CQMA 473K 50	C23, C24
CEA 331P 6	C25
CEA 101P 50	C26
CKDYB 471K 50	C27
CQMA 103K 400	C46

Note: When ordering resistors, convert the resistance value into code form, and then rewrite the part no. as before.

RESISTORS

Part No.	Symbol & Description
RD 1/4PM 000 J	R1-R12, R17-R22, R25, R26, R47, R48, R55, R56, R65-R68, R74-R84
RD 1/2PS 000 J	R13, R14
RD 1/4PSF 000 J	R15, R16, R23, R24, R27-R46, R49-R54
RD 1/4PSF 000 J	R57-R60
ACN-039	R61-R64
RN1H 000 K	R69, R70
RN2H 000 K	R71, R72
RS2P 000 J	R73
C92-063	VR5, VR6 Semifixed
ACP-002	VR7, VR8 Semifixed

SEMICONDUCTORS

Part No.	Symbol & Description
2SA979	Q1, Q2
2SC2291	Q3, Q4
2SA912	Q5, Q6
2SC1775A	Q7, Q8, Q21, Q22
2SC1885	Q9, Q10
2SC1400	Q11, Q12, Q17, Q18
2SA750	Q13-Q16
2SA872A	Q19, Q20
*2SC1913-R, Q	Q23, Q24
*2SA913-R, Q	Q25, Q26
*hfe of Q23-Q26 should have the same value.	
2SC1914A	Q27, Q28
2SC945A	Q29, Q30, Q32
(2SC1914A)	
2SA733A	Q31
(2SA904A)	
2SC1384	Q33
2S2076	D1-D6, D9-D16
(1S1555)	
(1S2473)	
STV2H	D7, D8
1S2471	D17-D20, D23
1S2472	D21, D22, D24
(1S1554)	
MZ-130	D25
(WZ-130)	

OTHERS

Part No.	Symbol & Description
ASR-052	RL1 Relay
ABA-139	Screw 3x6

Connector Assembly (AWX-062)

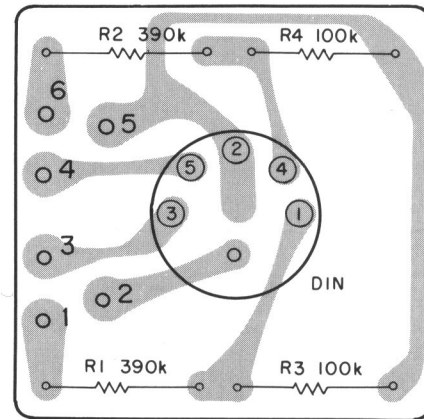
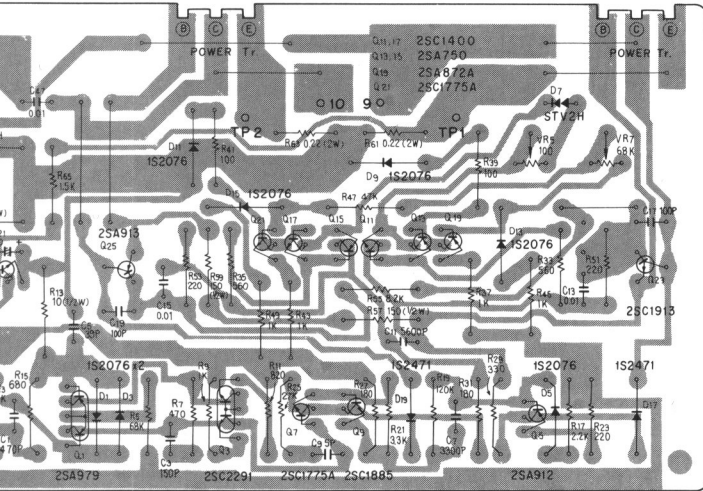

Part No.	Symbol & Description
RD¼PS □□□ J AKP-011	R1-R4 Connector socket (REC/PLAY)

Indicator Assembly (AWV-003)

The circuitry of the AWV-003 is the same as the AWV-001 (for KU type), with the exception of R14.

Symbol	Part No. (for AWV-003)	Part No. (for AWV-001)
R14	ACN-045	RS2P 271J

Volume Assembly (GWX-268)

The circuitry of the GWX-268 is the same as the GWX-258 (for KU type), with exception of the P.C. board material.

Switch Assembly 1 (GWS-174)

The circuitry of the GWS-174 is the same as the GWS-169 (for KU type), with the exception of the P.C. board material.

Terminal Assembly (GWX-269)

The circuitry of the GWX-269 is the same as the GWX-259 (for KU type), with exception of the P.C. board material.

Phone jack Assembly (GWX-270)

The circuitry of the GWX-270 is the same as the GWX-260 (for KU type), with the exception of the P.C. board material.

Power Supply Assembly (GWR-114)

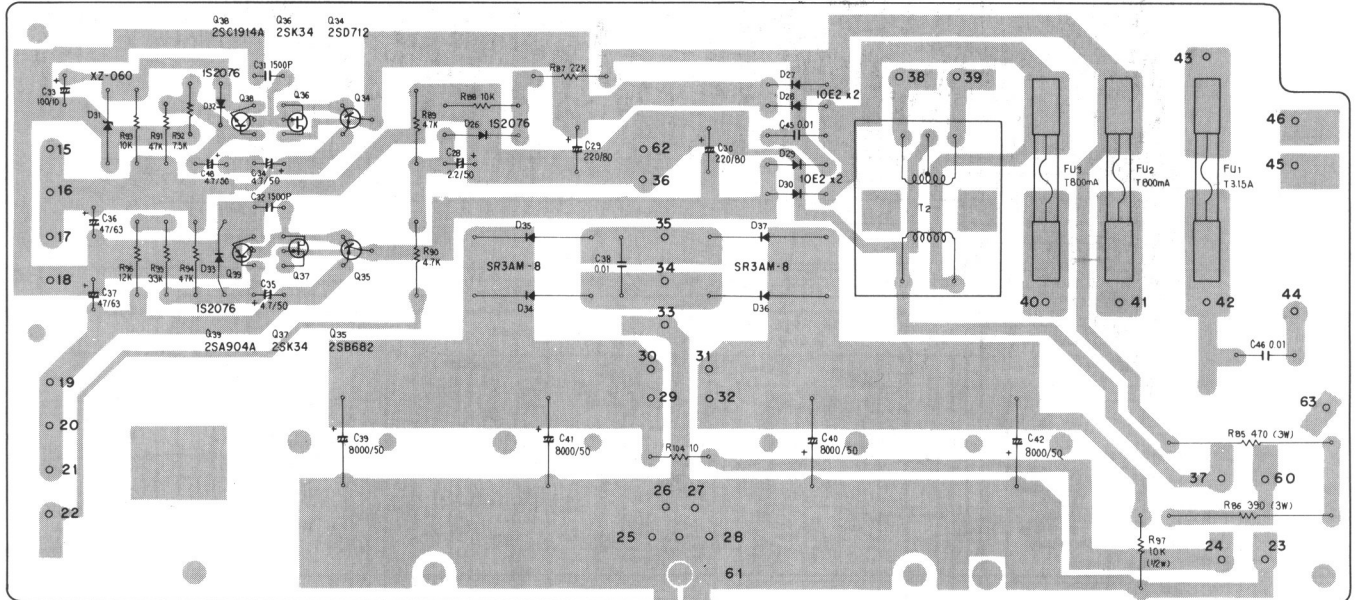

Parts List

CAPACITORS

Part No.	Symbol & Description
CEA 2R2P 50	C28
CEA 221P 80	C29, C30
CKDYB 152K 50	C31, C32
CEA 101P 10	C33
CEANL 4R7M 50	C34, C35, C48
CEA 470P 63	C36, C37
ACG-004	C38, C45 Ceramic 0.01/150V
ACH-082	C39-C42 Electrolytic 8000/50V
⚠ ACG-001	C46 Ceramic 0.01/250V

Note: When ordering resistors, convert the resistance value into code form, and then rewrite the part no. as before.

RESISTORS

Part No.	Symbol & Description
RS3P 000 J	R85, R86
RD¼PM 000 J	R87-R96
RD¼PS 000 J	R97
⚠ RF¼PS 000 J	R104

SEMICONDUCTORS

Part No.	Symbol & Description
2SD712	Q34
2SB682	Q35
2SK34	Q36, Q37
2SC1914A (2SC1890A)	Q38
2SA904A (2SA893A)	Q39
1S2076 (1S1555)	D26, D32, D33
⚠ 10E2 (SIB01-02)	D27-D30
XZ-060	D31
⚠ SR3AM-8	D34-D37

OTHER

Part No.	Symbol & Description
ATT-577	T2 Heater transformer